

U • P • I CO., LTD.



YOKOHAMA
JAPAN

Date : 2012.05.31

Pressure Type Tank Level Sensor

Sensor Type : CT with Ceramic Diaphragm Protection

7-2, 4-Chome, Kamitsuchidananka, Ayase-shi, Kanagawa 252-1113, Japan

☎: +81 (0) 467 40 5983 Fax: +81 (0) 467 40 5984



PRESSURE TYPE TANK LEVEL AND DRAFT REMOTE MEASURING SYSTEM

Overview

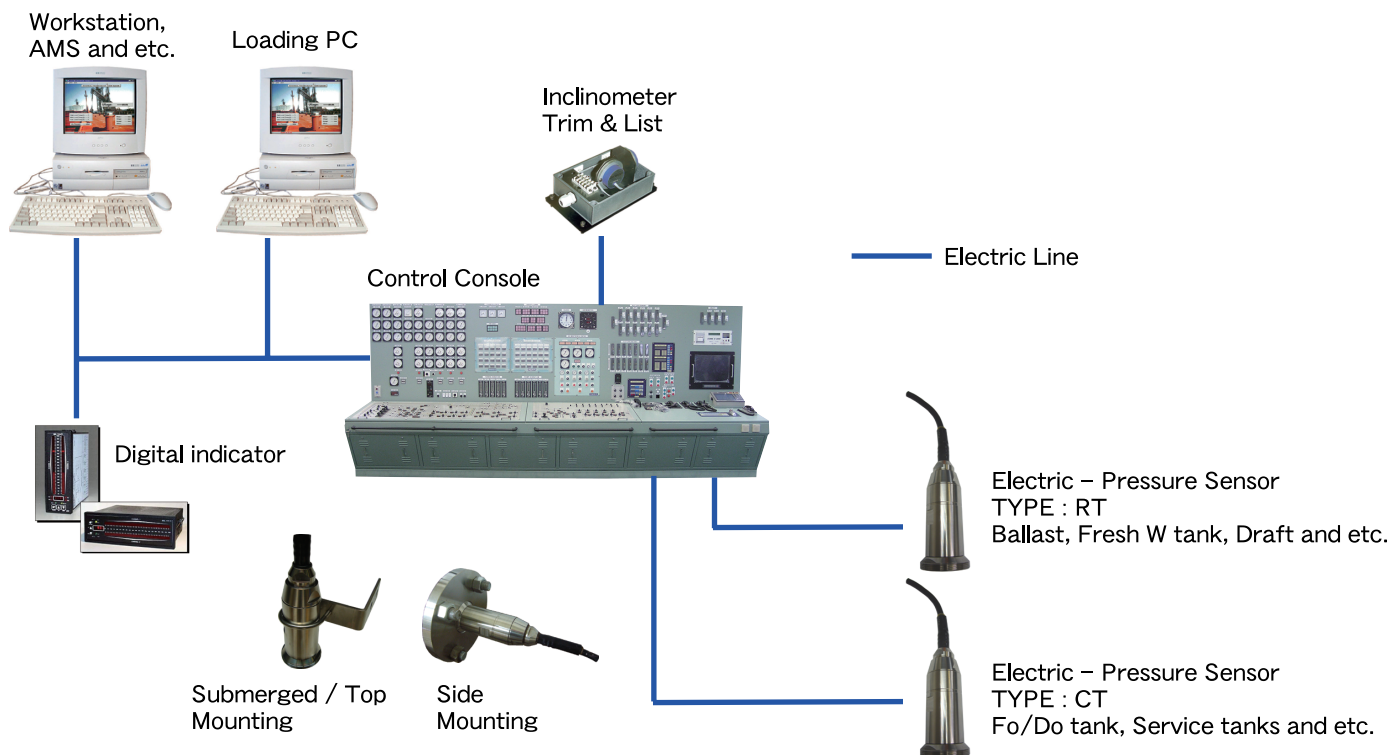

Sensor Type : RT with FKM diaphragm protection

Type RT series pressure transmitters are specially designed for use in demanding **Sea/Fresh Water tanks** and draft level gauging application. The integral 2-wire, 4-20mA electronics provide power supply regulation, reverse polarity, overvoltage and EMC protection.



Sensor Type : CT with Ceramic diaphragm protection

Type CT series pressure transmitters are specially designed for use in demanding **Variety of Oil tanks** level gauging application. The integral 2-wire, 4-20mA electronics provide power supply regulation, reverse polarity, over voltage and EMC protection.

Your benefits

- Capacitive transmitter with FKM / Ceramic diaphragm
- Show good corrosion-resistance against variety of Sea Water / Oil
- Type CT sensor can be measure liquid Temperature (Pt100Ω) with a level measuring
- High overload limit
- High temperature stability
- Long-term stability
- Extended performance with the level remote measuring system
- Approved by major classification societies

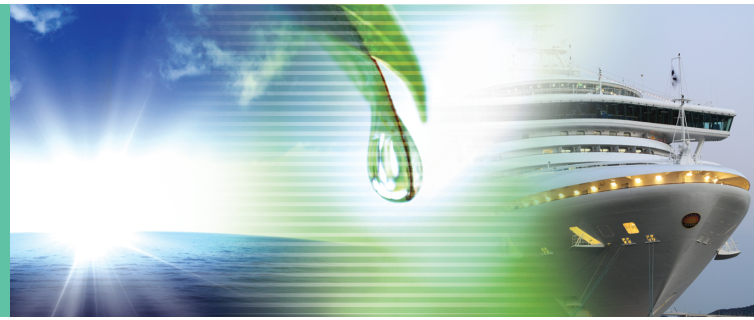

Technical data

- Gauge pressure range : 0.5 / 1.0 / 2.0 / 3.5 kgf/cm² (up to 35.0m),
Option : Deeper ranges are available
- Pressure containment : 6 / 10 / 15 / 25 kgf/cm² (for respective pressure range)
- Cable length : 3m in standard, Option : up to 35m (Longer cable is available),
Material : Can be select Polyethylene (PE) or Fluorocarbon Polymers (FEP) cable
- Protection class : IP68 (Body material SUS316)
- Explosion-proof : Ex ia IIC T6 ■ Power supply : DC24V±10%
- Operating temperature ranges : -25° to 80 / 120°C
- Output signal : 4-20mA, 2-wires ■ Temperature measuring (Option) : Pt100Ω
- Accuracy : ±0.25% FS at 20°C
- Temperature effects : 0.015% / °C (-25° to 80 / 120°C not freeze) ■ EMC Protection
- Electrostatic discharge protection : Contact discharge 6kV spike test to IEC61000-4-2 without damage applied between excitation lines and case.



Approvals

- NK certificate of approval for liquid level gauge / high level alarm :
Certificate No. TA10425M
- BV Mode II Scheme factory / quality approval :
Certificate No. SMS.W.II. / 81515 / A.0
Certificate No. SMS.W.II. / 81360 / A.0
- ABS certification of liquid level sensor :
Certificate No. YO1939117
- CCS, LR : Inspected by the surveyer to the society and are found to comply with the requirements before shipping.



Installation

Tank Level Gauge
Outside Tank

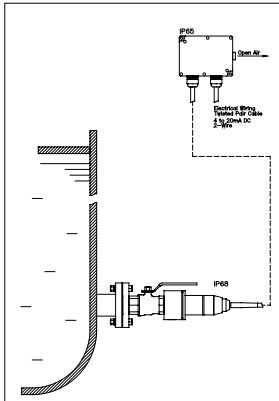

Tank Level Gauge
Outside Tank

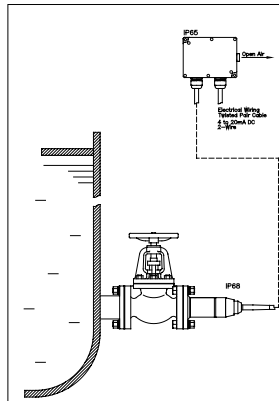

Tank Level Gauge
In Tank

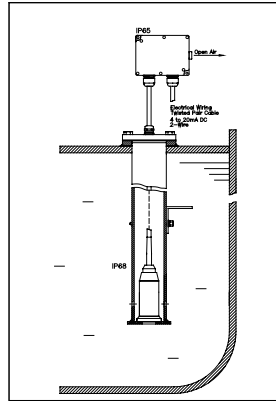

Tank Level Gauge
In Tank

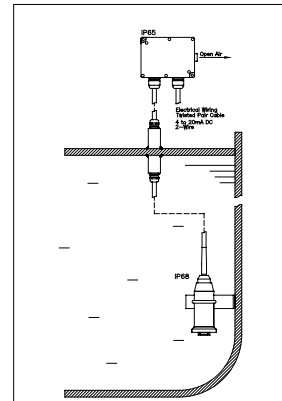

Draft Level Gauge

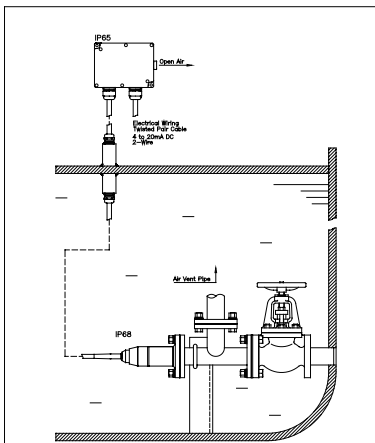

Draft Level Gauge

